

SYSTEMATIK DER KLÄNGE UND SKALEN

Es gibt 1 Einklang
6 Zweiklänge

19 Dreiklänge
43 Vierklänge

66 Fünfklänge
80 Sechsklänge

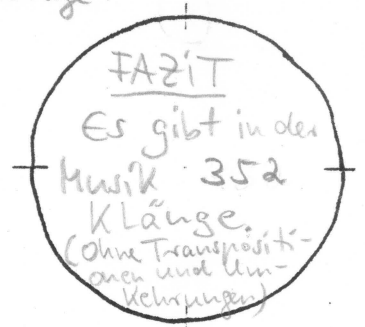
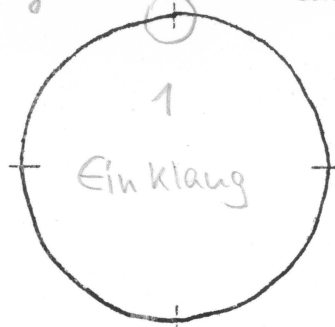
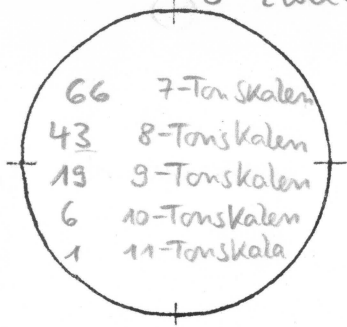

II Zweiklänge (Intervalle)

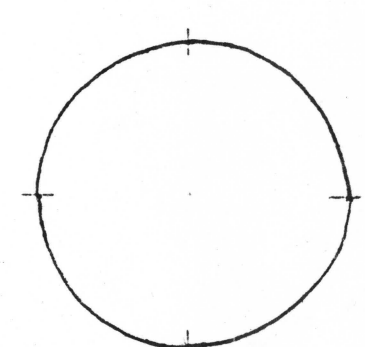
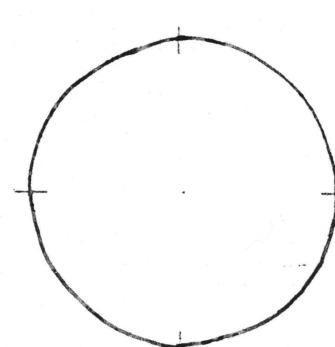
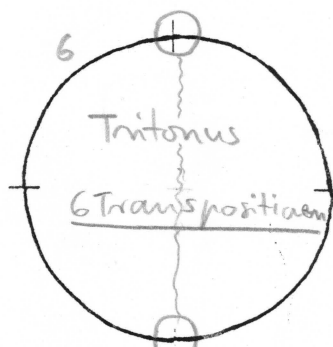
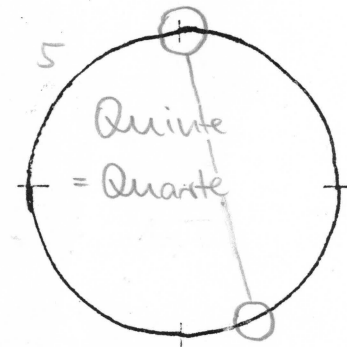
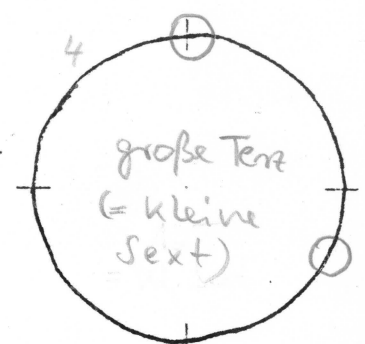
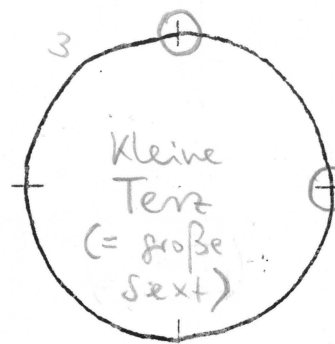
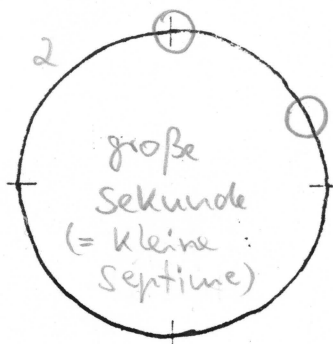
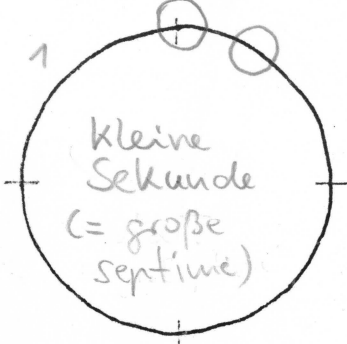

III Dreiklänge

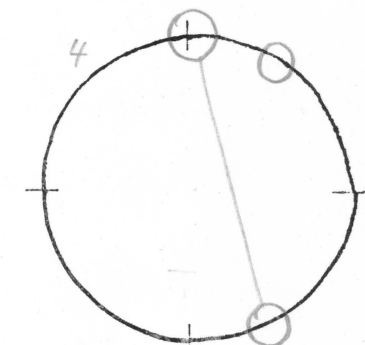
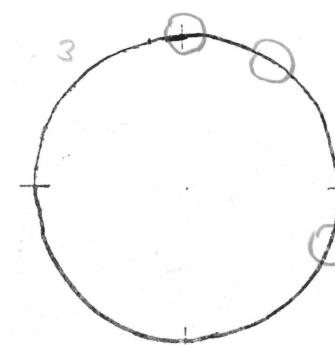
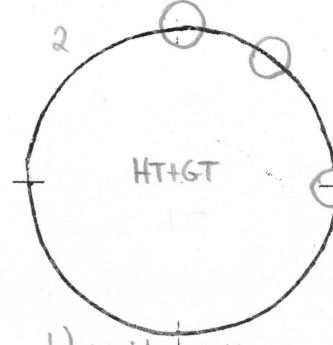
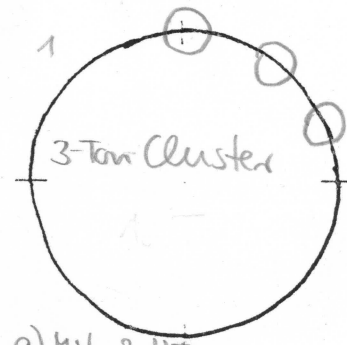

a) mit 2 HT

b) mit 1 HT

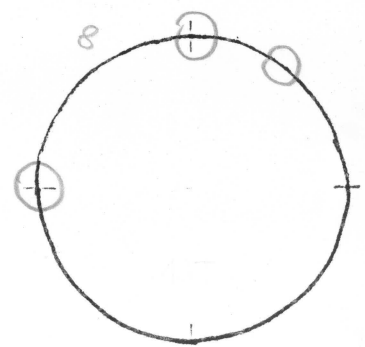
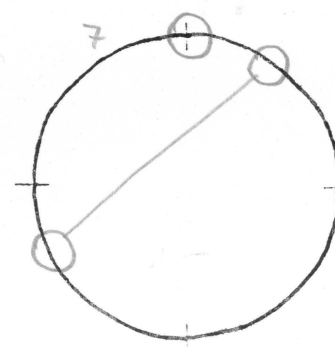
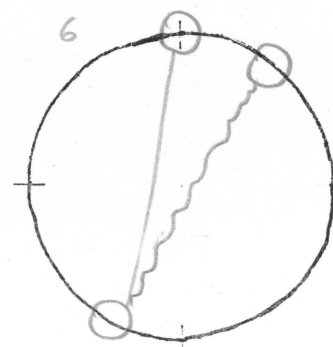
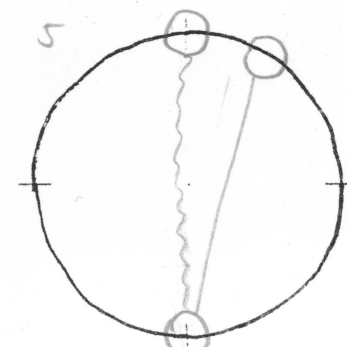

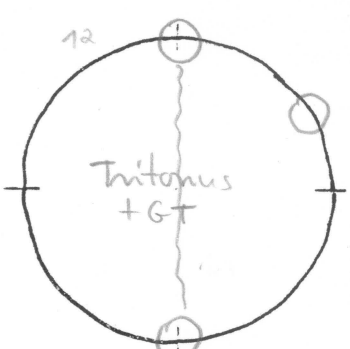
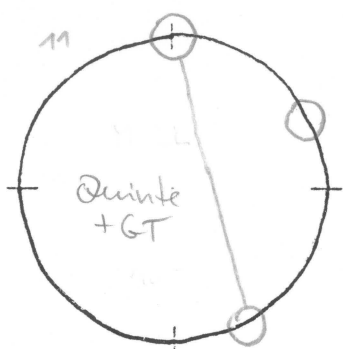
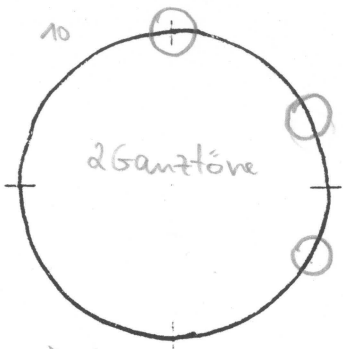
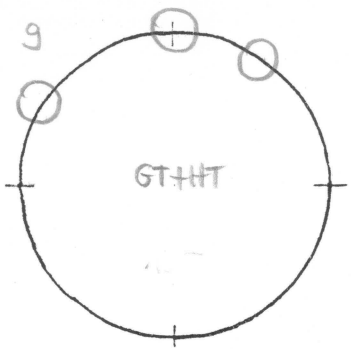

c) ohne HT mit GT

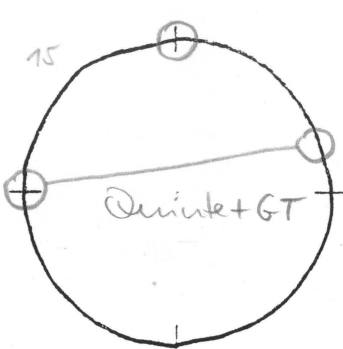
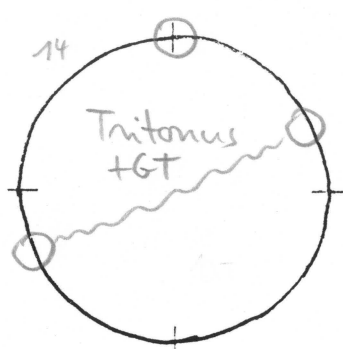
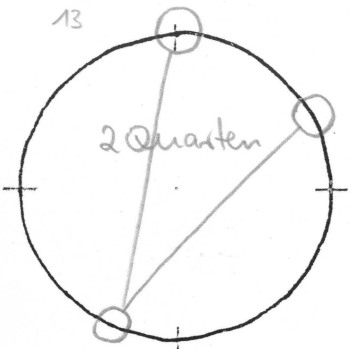

d) ohne HT, ohne GT

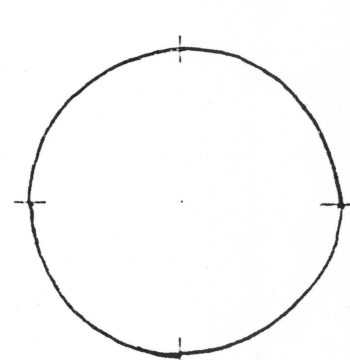
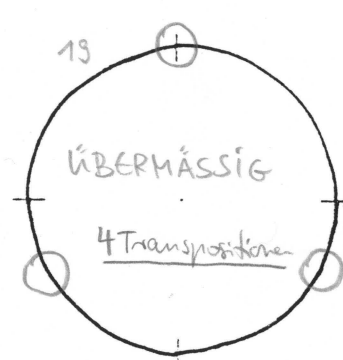
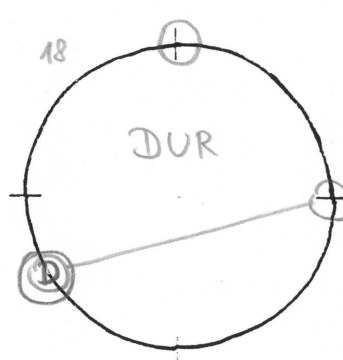
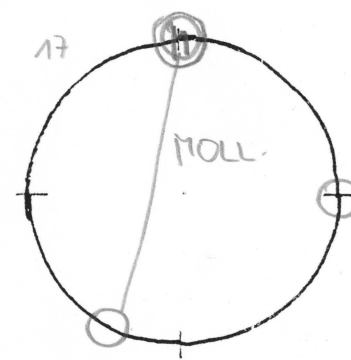

IV Vierklänge

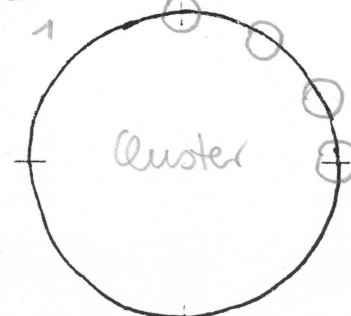

a) mit 3 HT

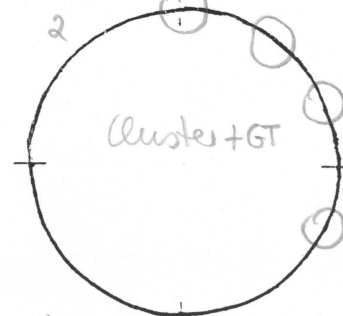

b) mit 2 HT

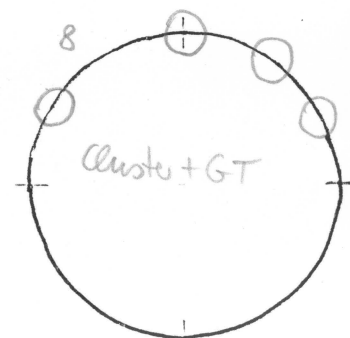
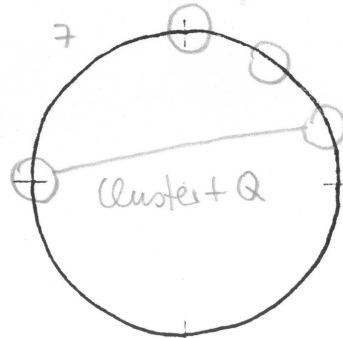
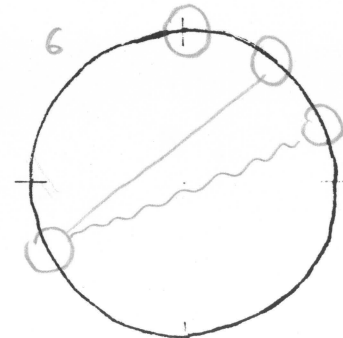
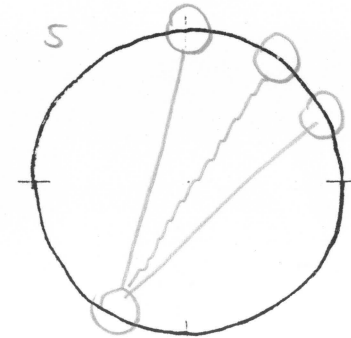
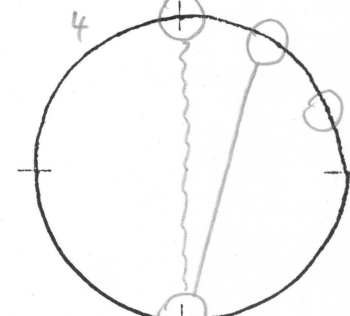
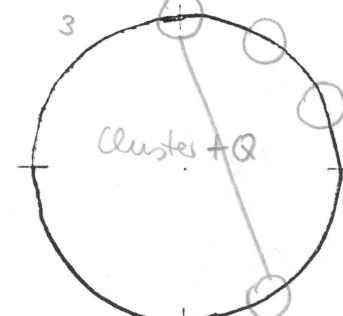

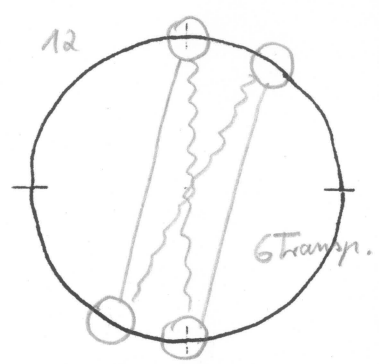
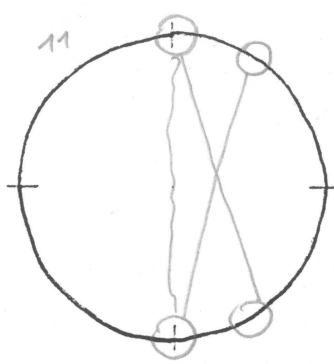
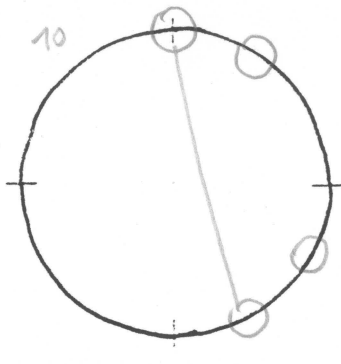
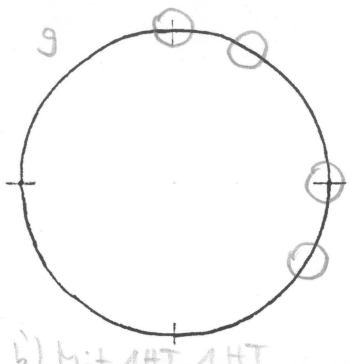

b) Mit 1HT, 1HT

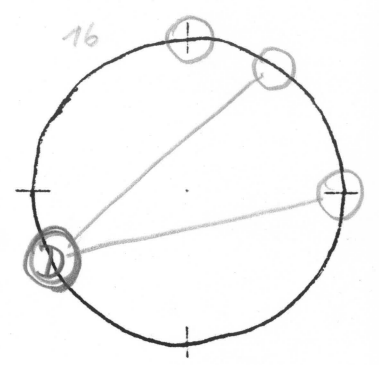
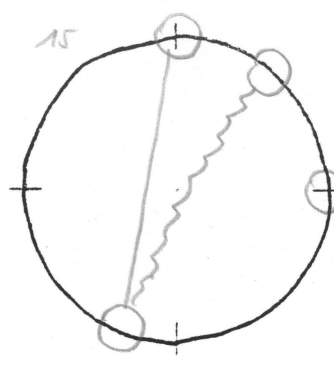
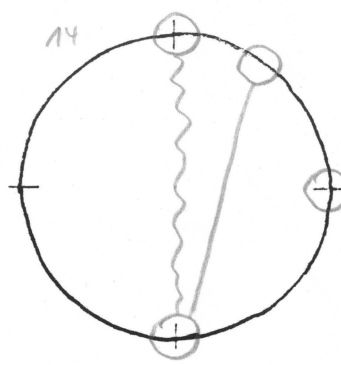
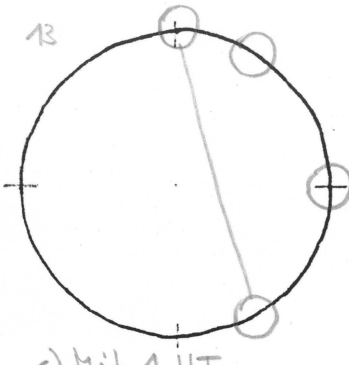

c) Mit 1HT

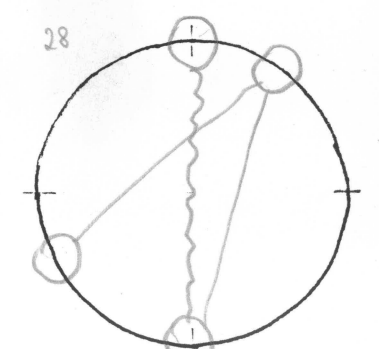
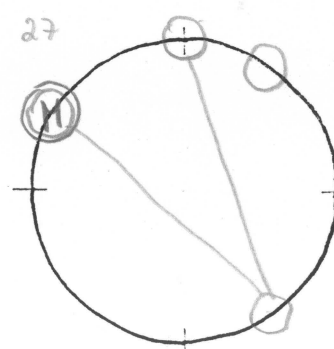
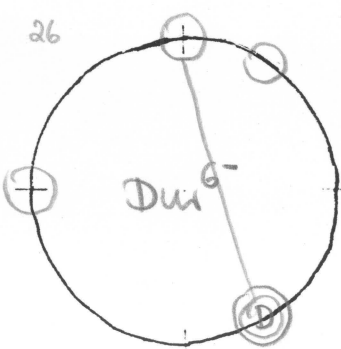
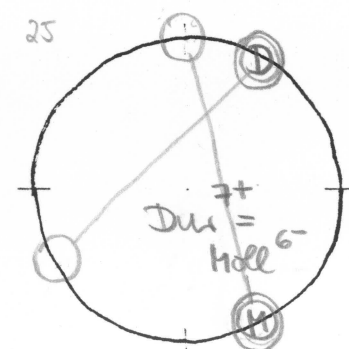
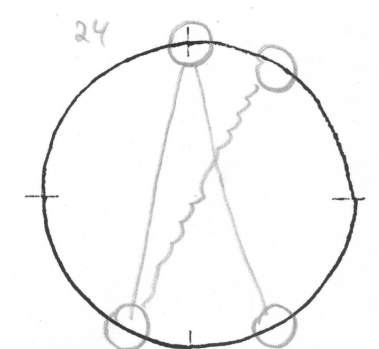
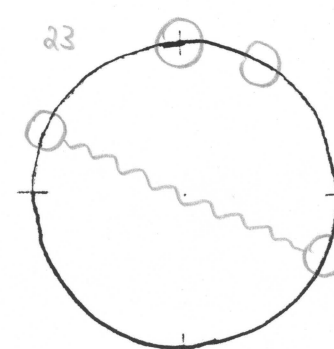
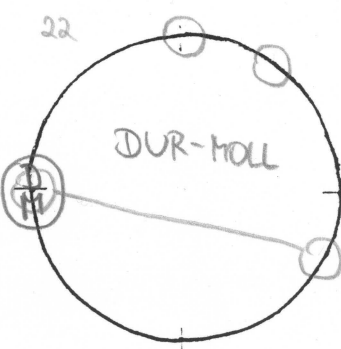
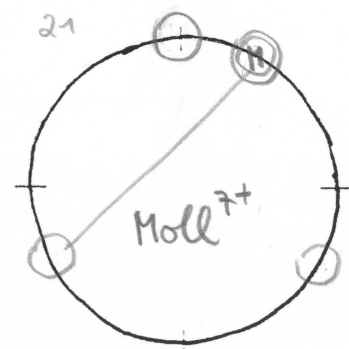
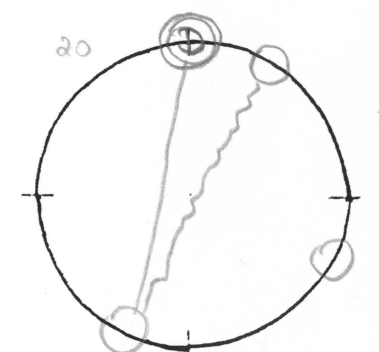
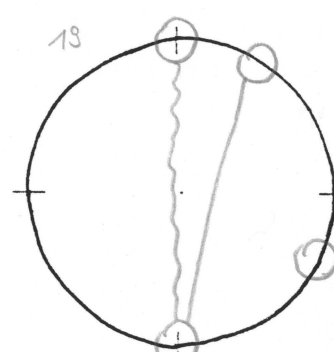
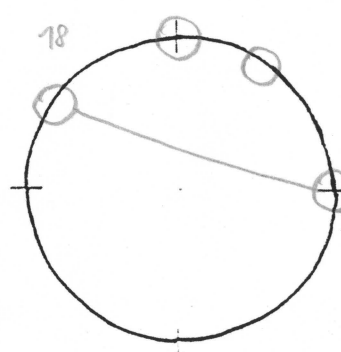
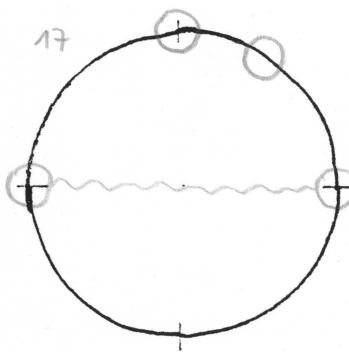

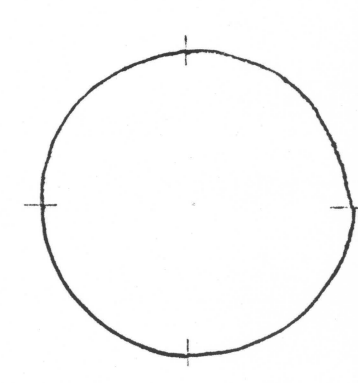
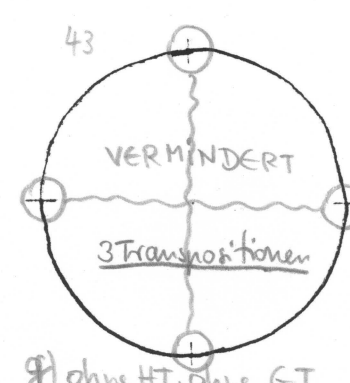
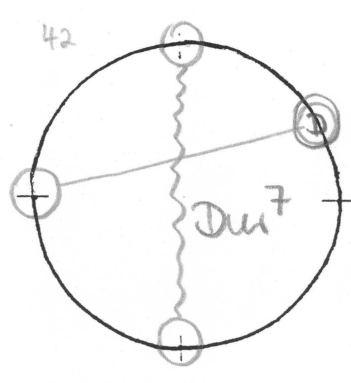
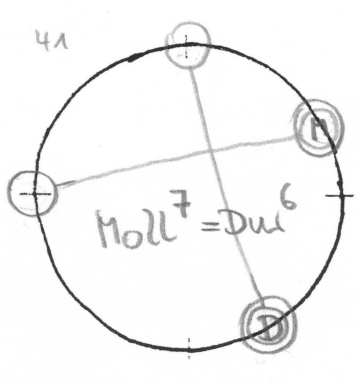
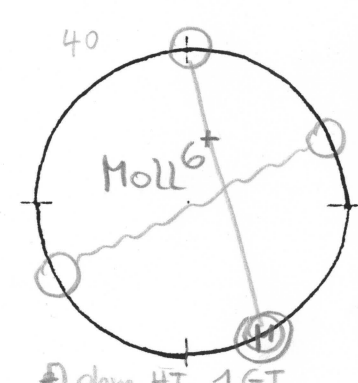
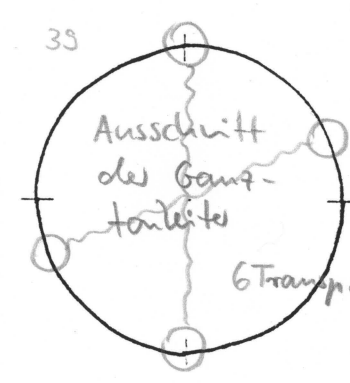
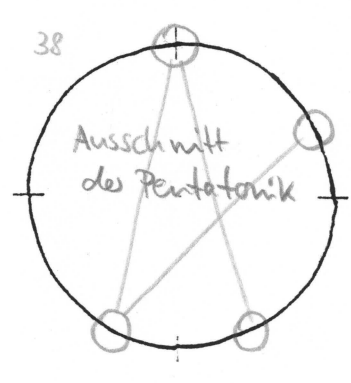
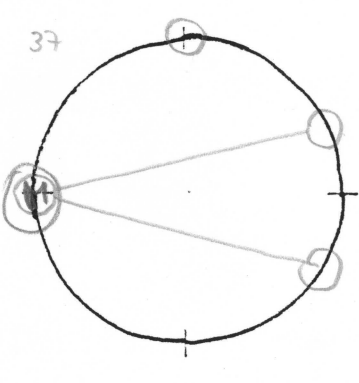
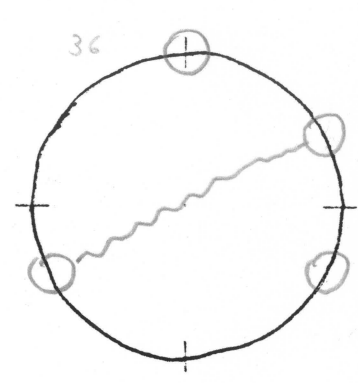
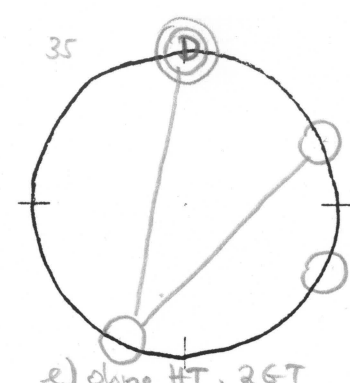
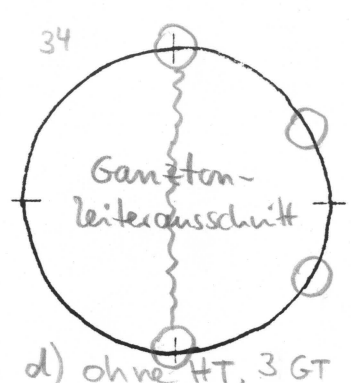
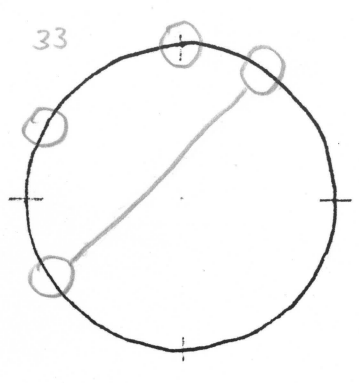
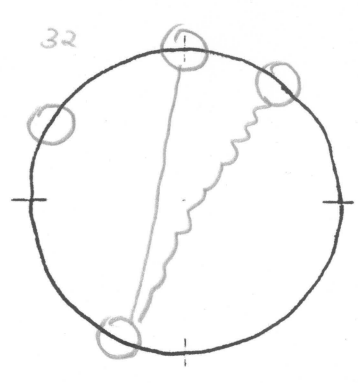
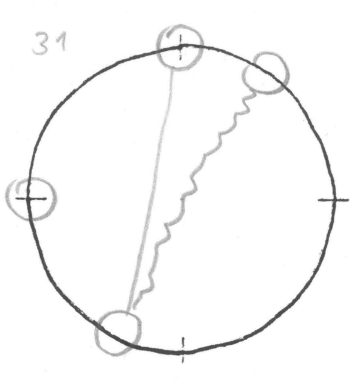
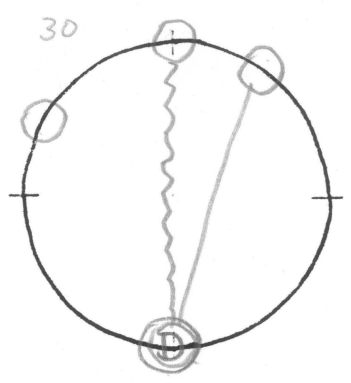
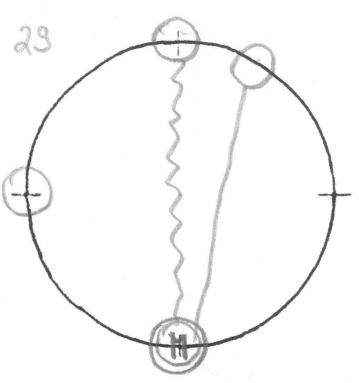

V 5-Klänge

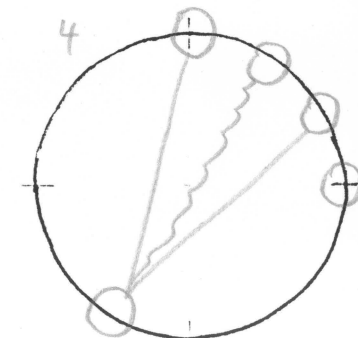
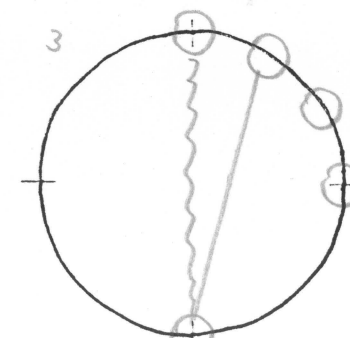
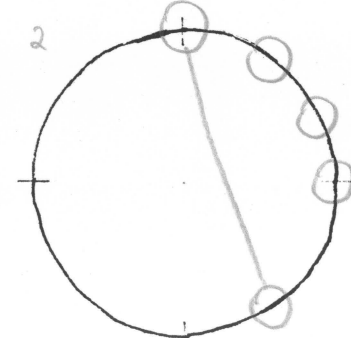
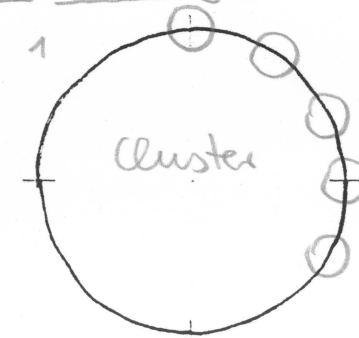

a) Mit 4 HT

b) Mit 3 HT

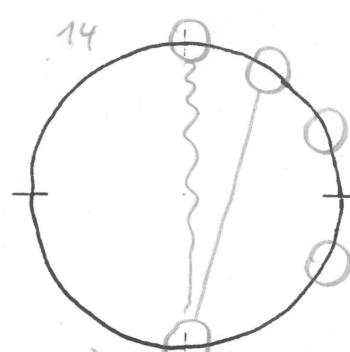
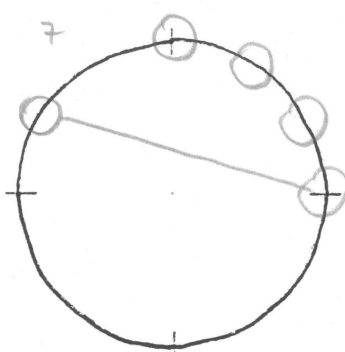
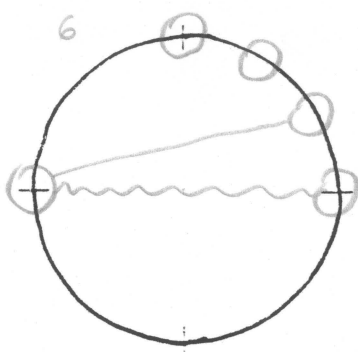
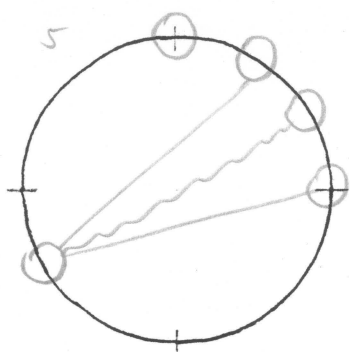

c) mit 2 HT nebeneinander

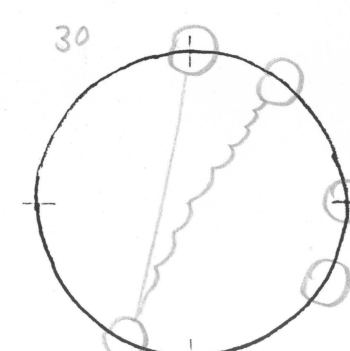
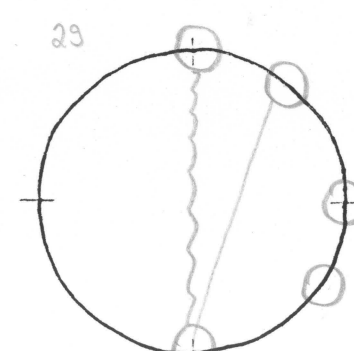
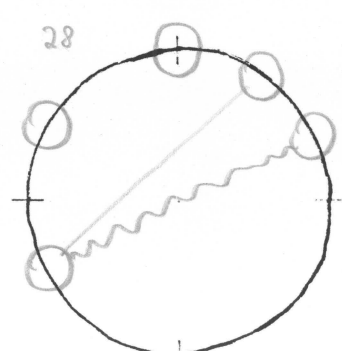
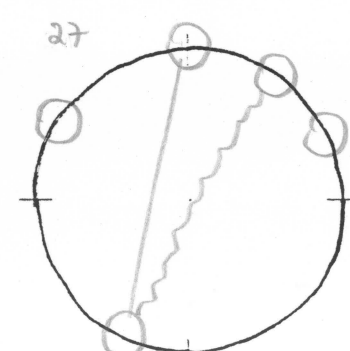
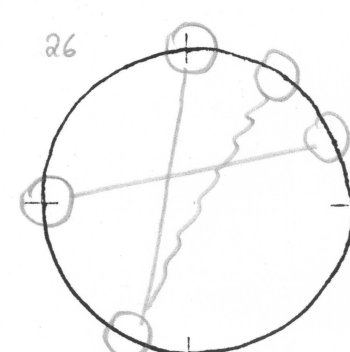
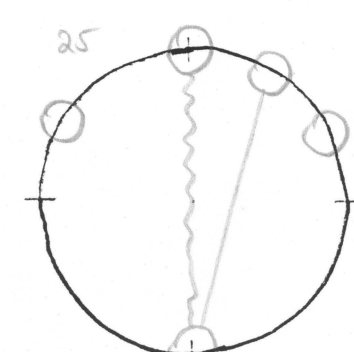
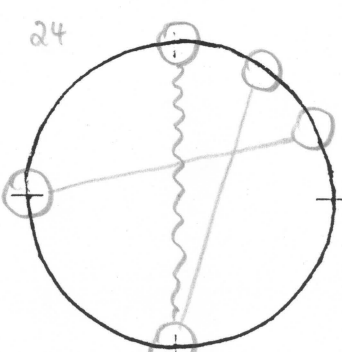
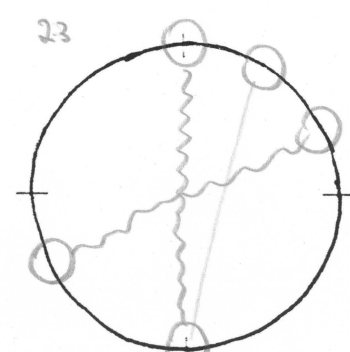
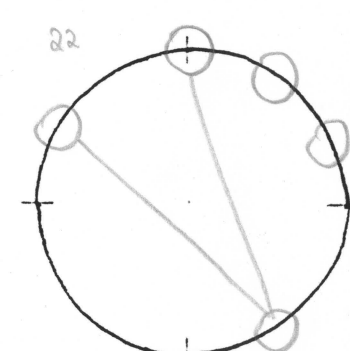
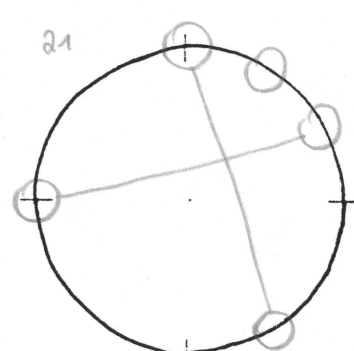
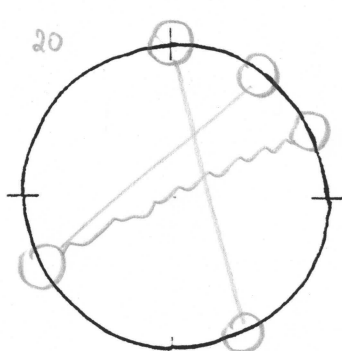
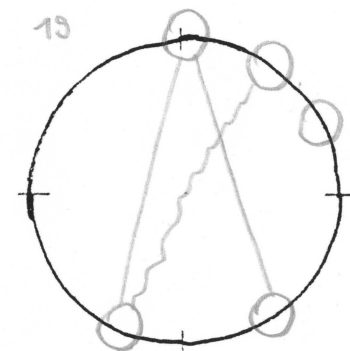
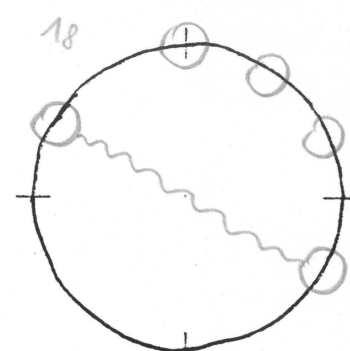
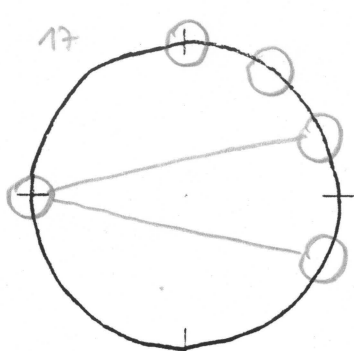
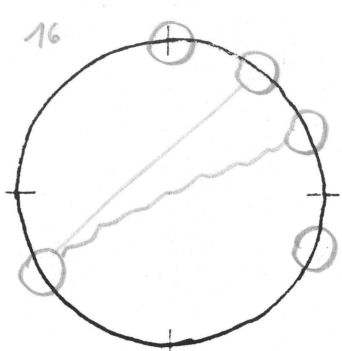
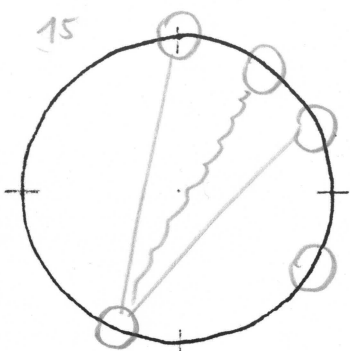

d) mit 2 HT auseinander

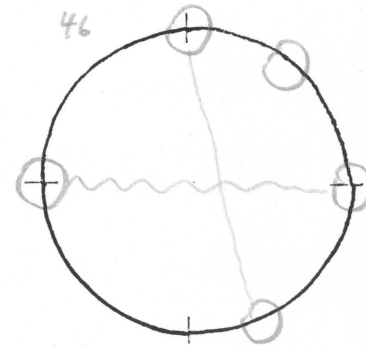
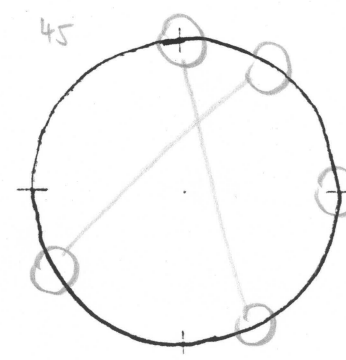
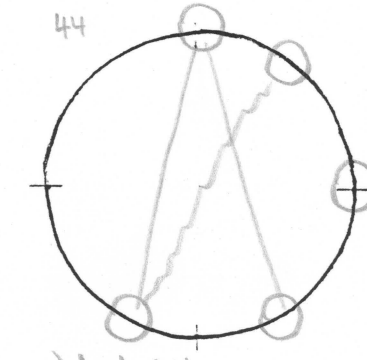
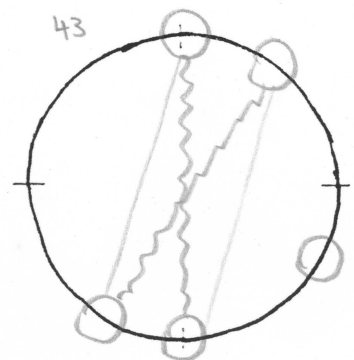
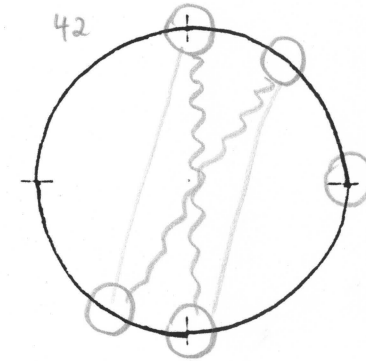
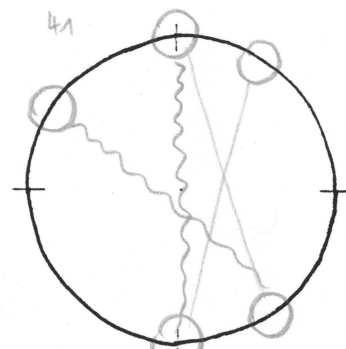
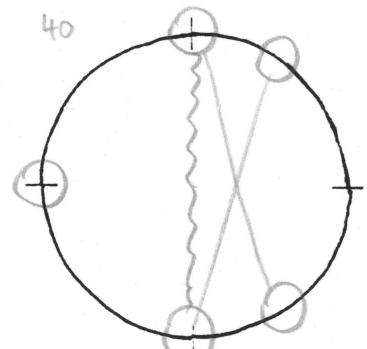
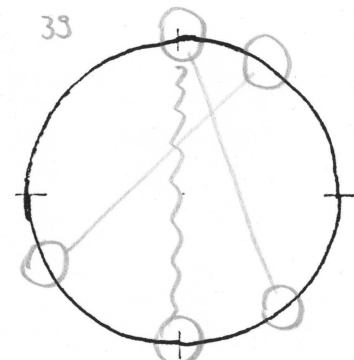
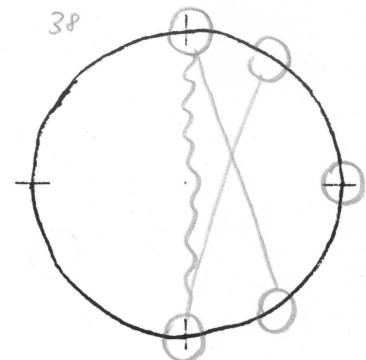
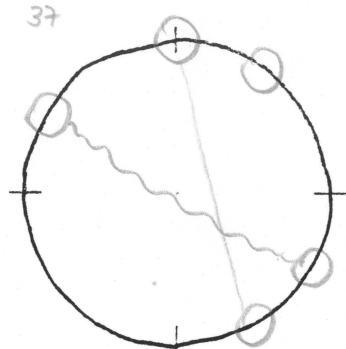
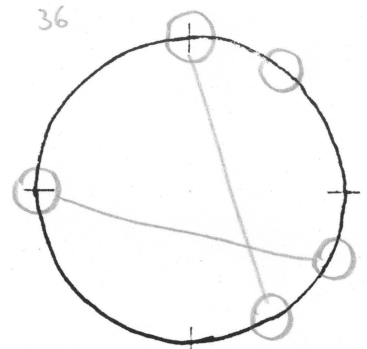
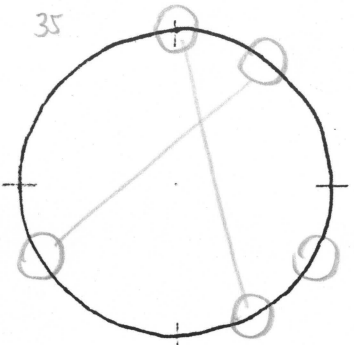
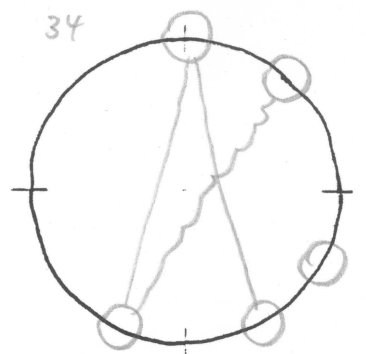
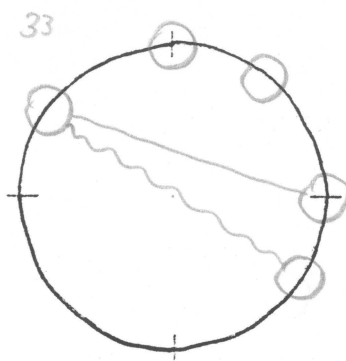
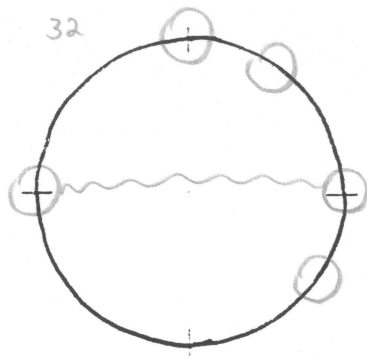
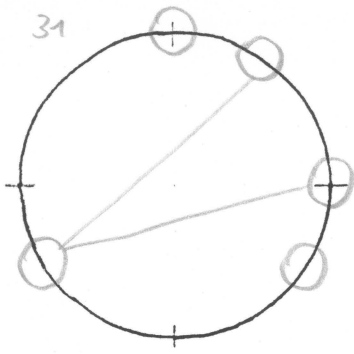

e) mit 1 HT

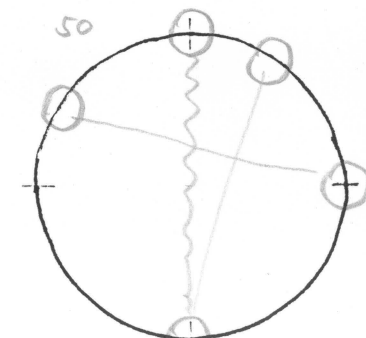
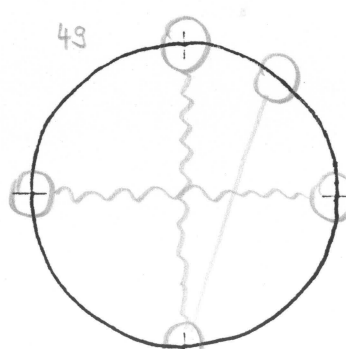
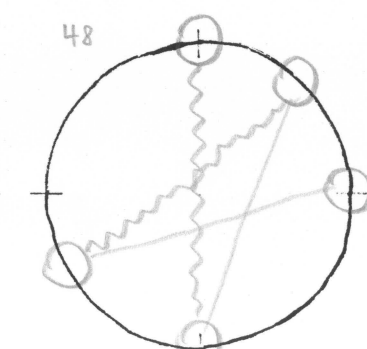
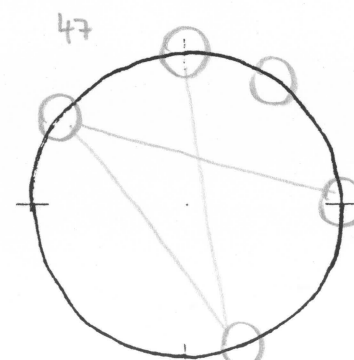

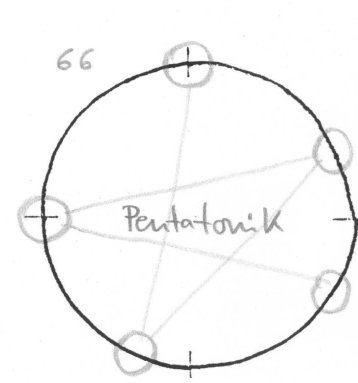
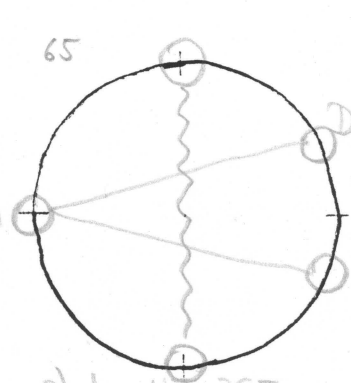
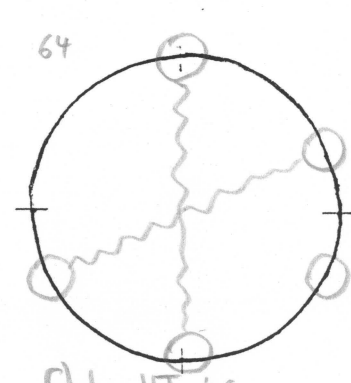
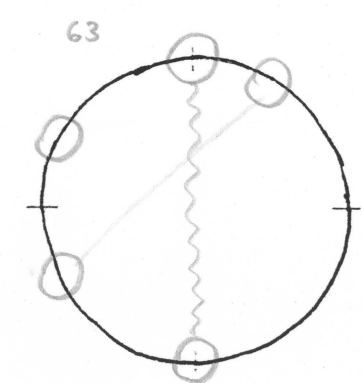
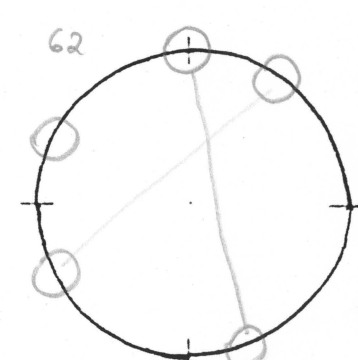
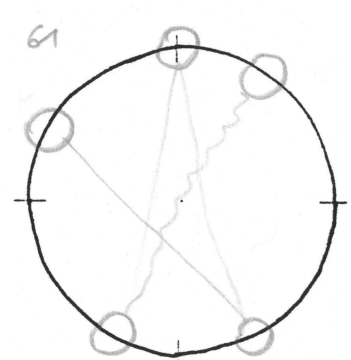
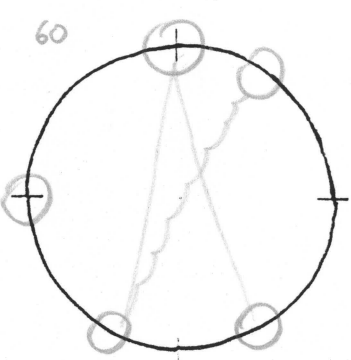
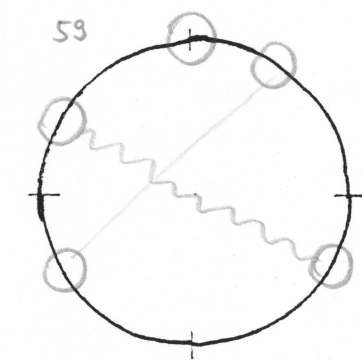
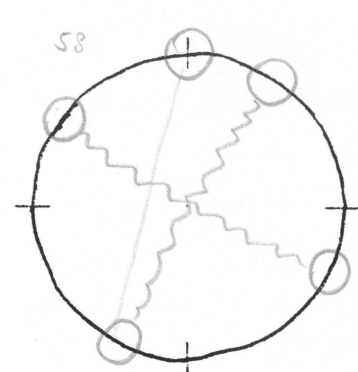
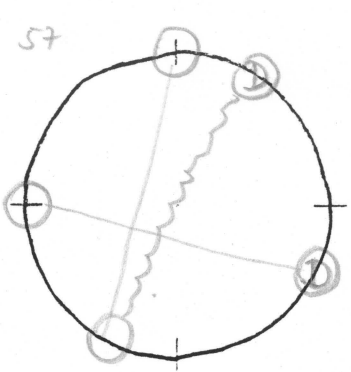
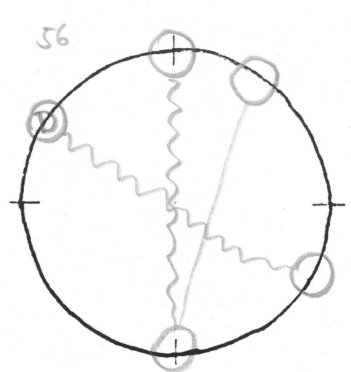
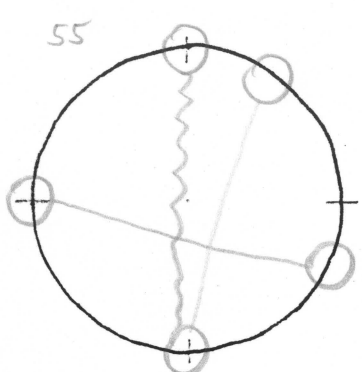
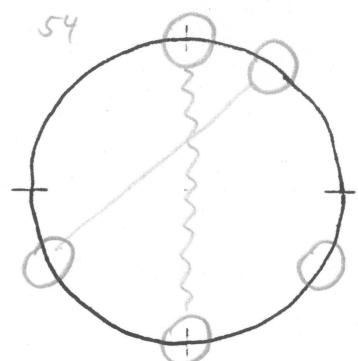
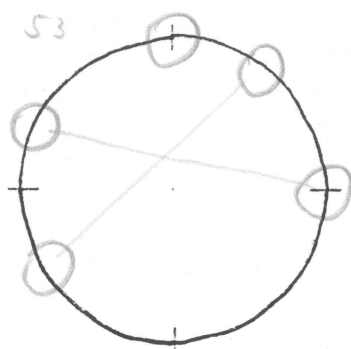
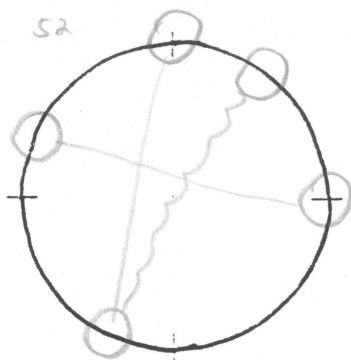
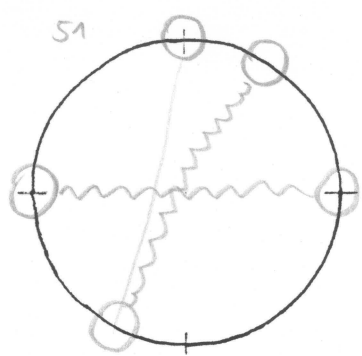

f) ohne HT, 4G

g) ohne HT, 3GT

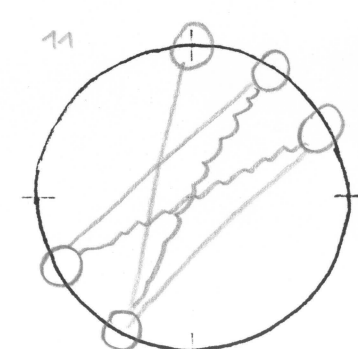
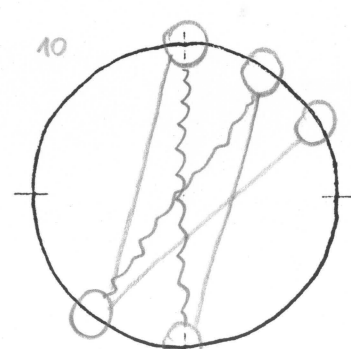
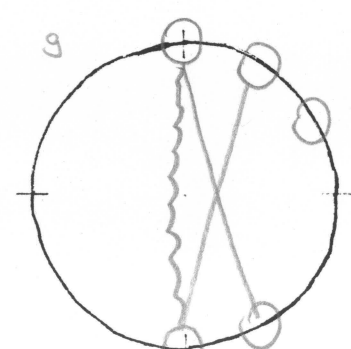
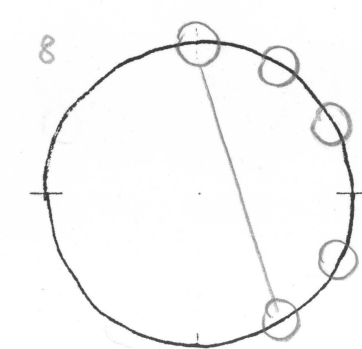

h) Ergänzung zu b: